

Thread Seals

Inch and Metric Sizes

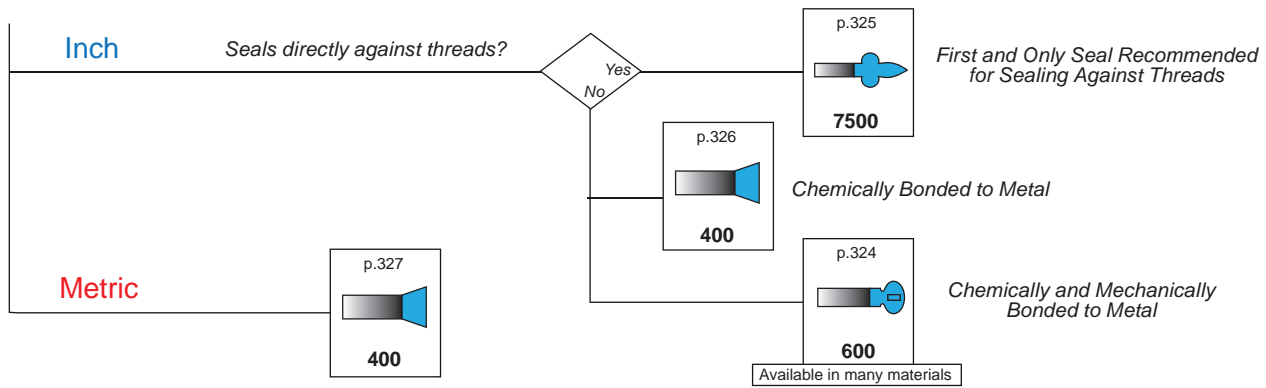

Split Flange Seal

Inch Sizes

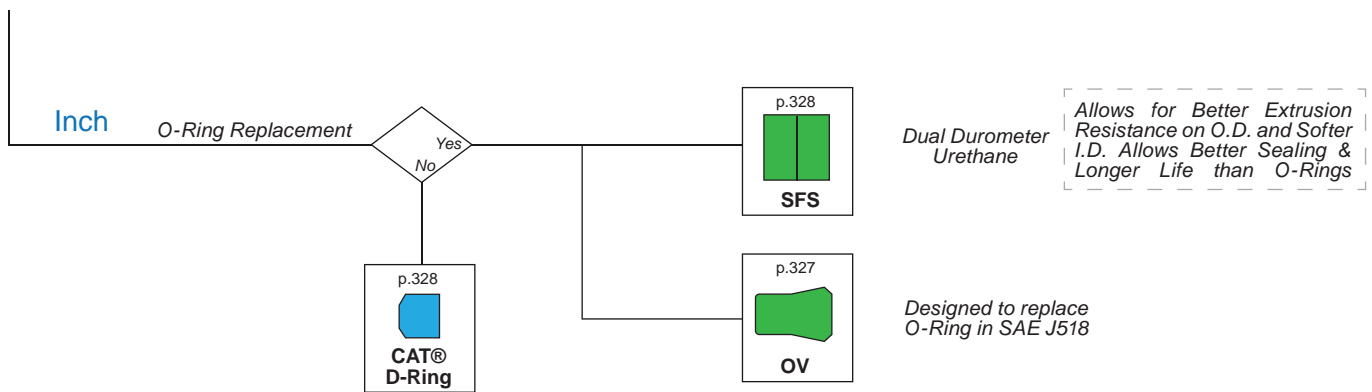

3869 Fluid Connector Seal (DIN Standard 3869)

Metric Sizes

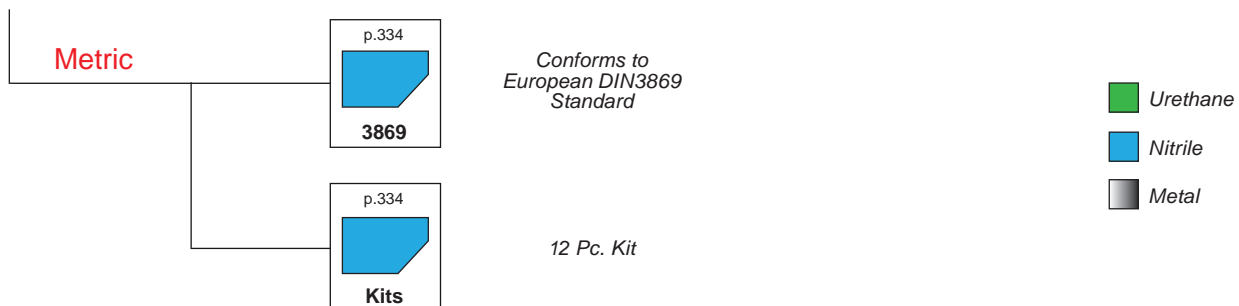

Wiper Applications

Hydraulic

Inch Sizes

Over 30 Styles in Stock

Custom Machined Wiper Profiles pg. IX

Hydraulic

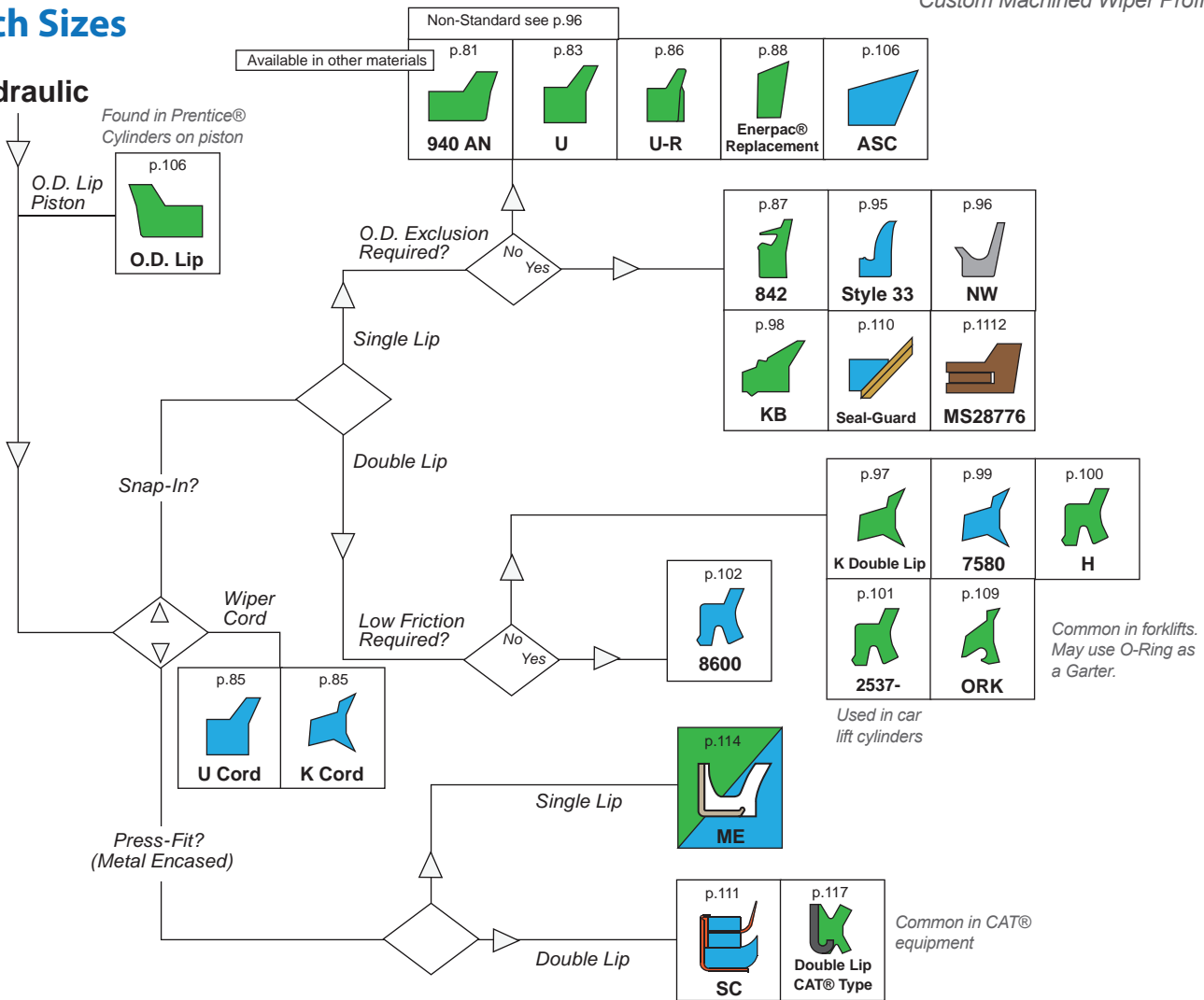

End Cap / Head Seal

Inch Sizes

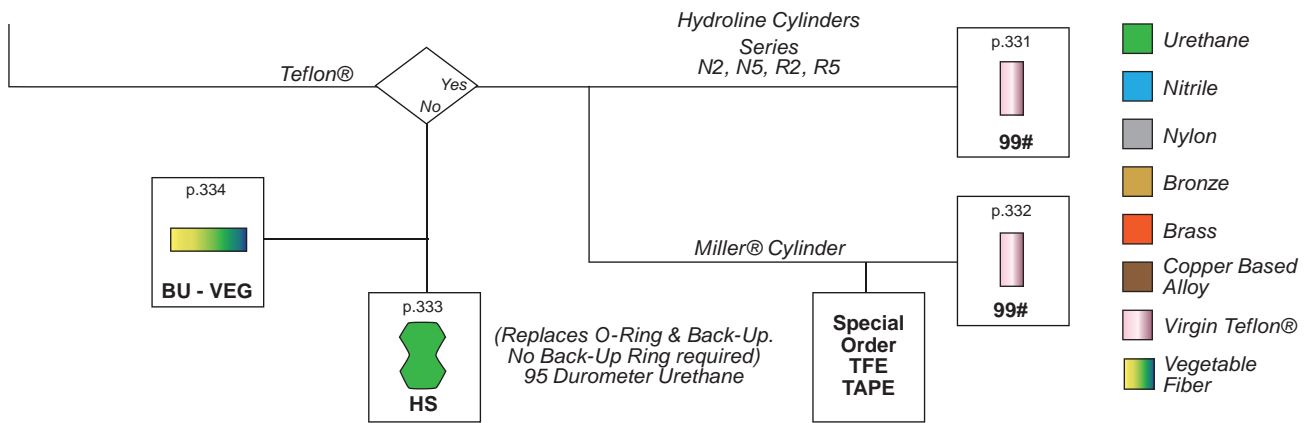

Wiper Applications Hydraulic Metric Sizes

Over 20 Styles in Stock

Custom Machined Wiper Profiles pg. VIII

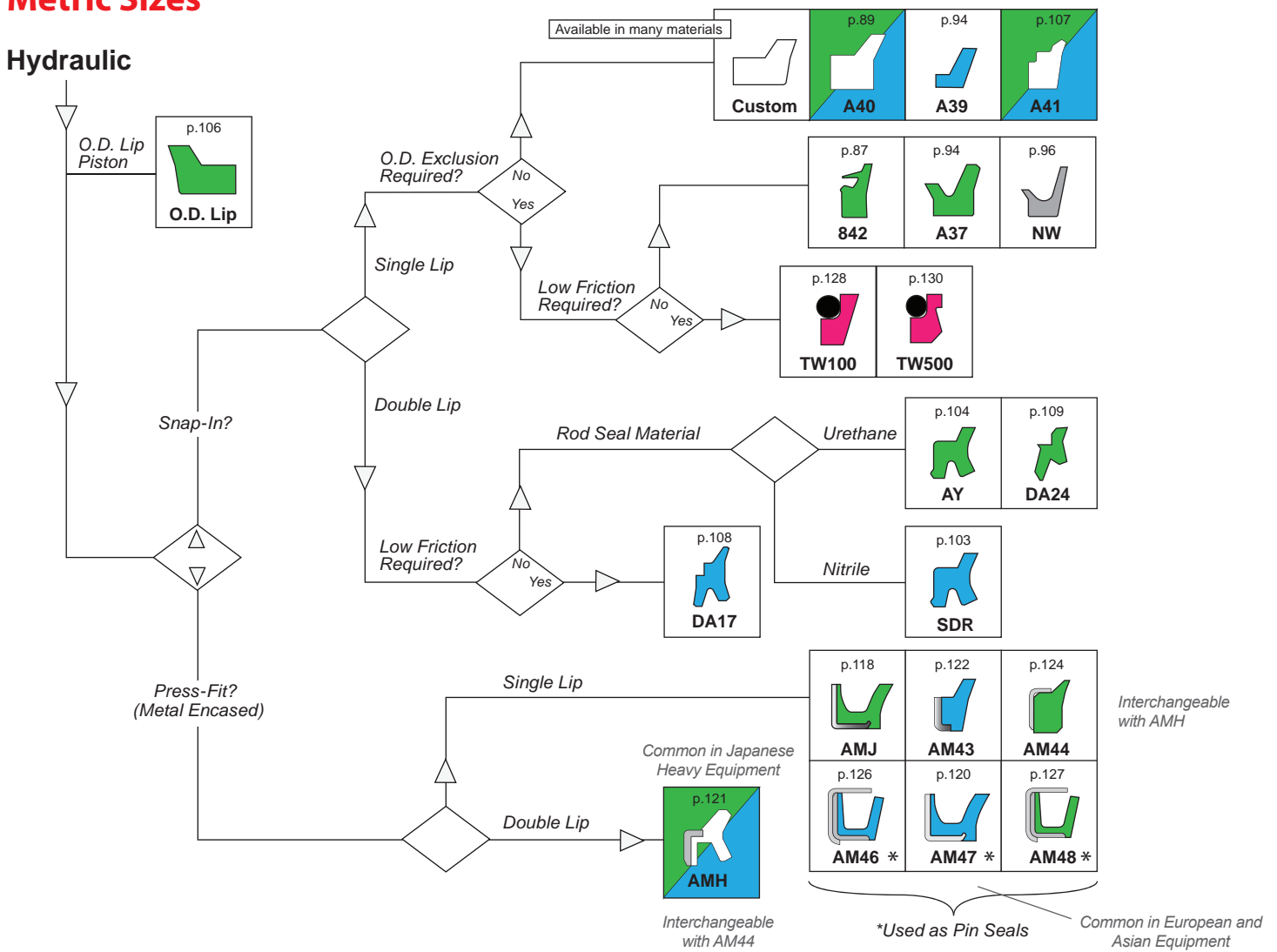

End Cap / Head Seal Metric Sizes

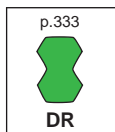

- Material Availability**
- Urethane
 - Nitrile
 - Teflon®
 - Nylon
 - Steel
 - Energizers can be Nitrile or Viton

Rod Gland Seal Applications

Hydraulic

Inch Sizes

25 Styles in Stock

Custom Machined Rod Profiles pg. IX

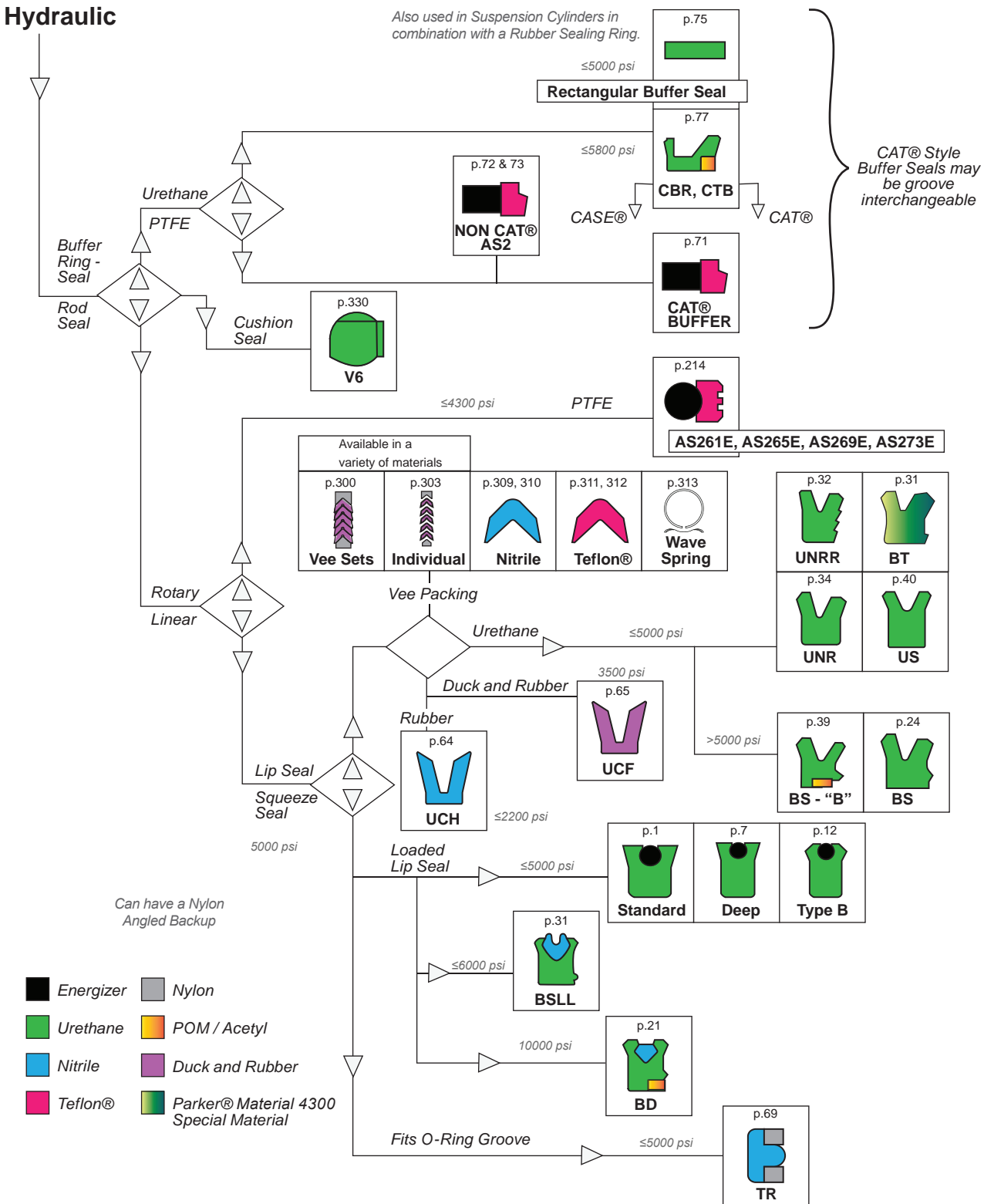

Rod Gland Seal Applications

Hydraulic

Metric Sizes

Over 25 Styles in Stock

Custom Machined Rod Profiles pg. VIII

Hydraulic

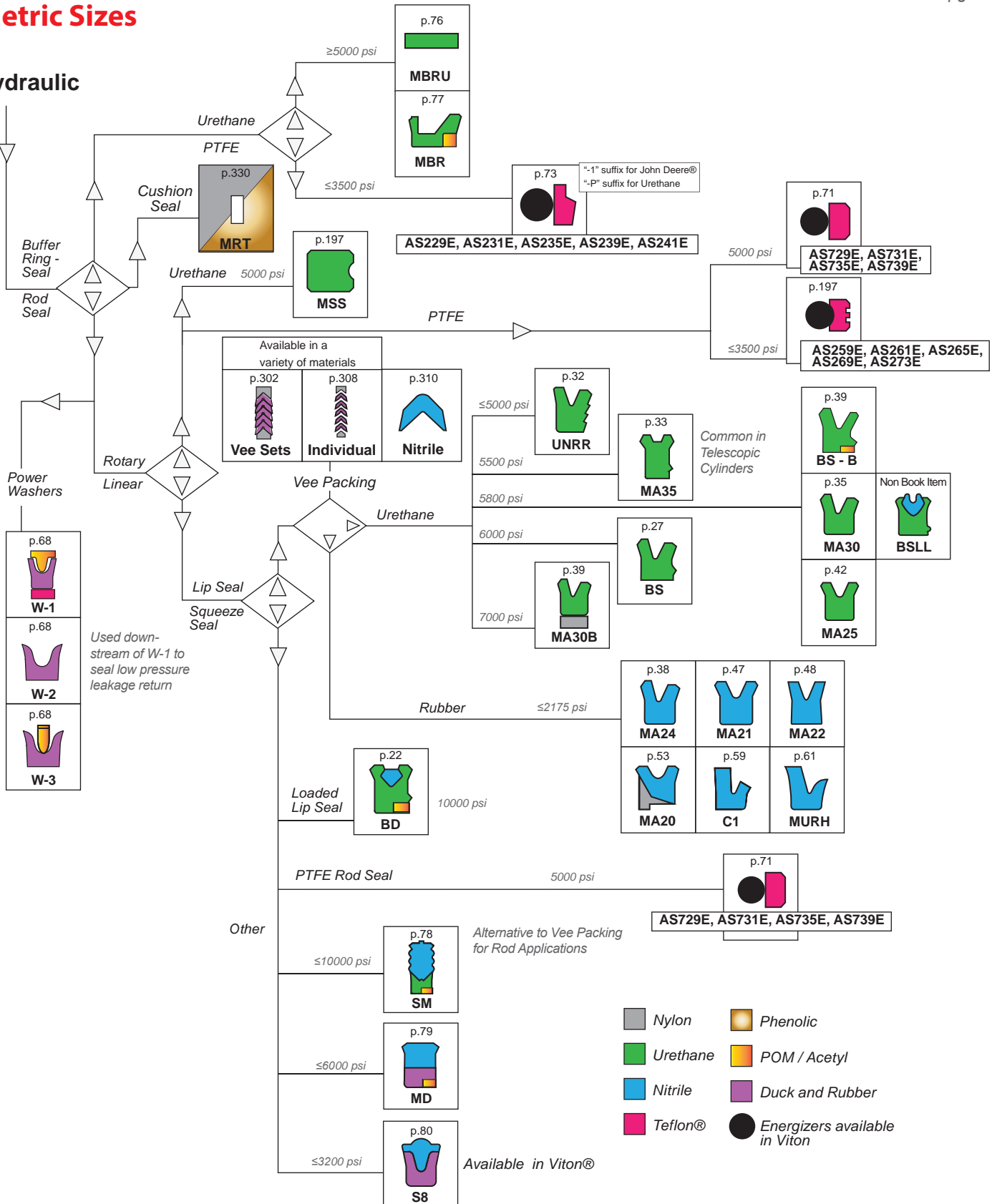

Piston Seal Applications

Hydraulic

Inch Sizes

Over 50 Styles in Stock
 Custom Machined Piston Profiles pg. IX

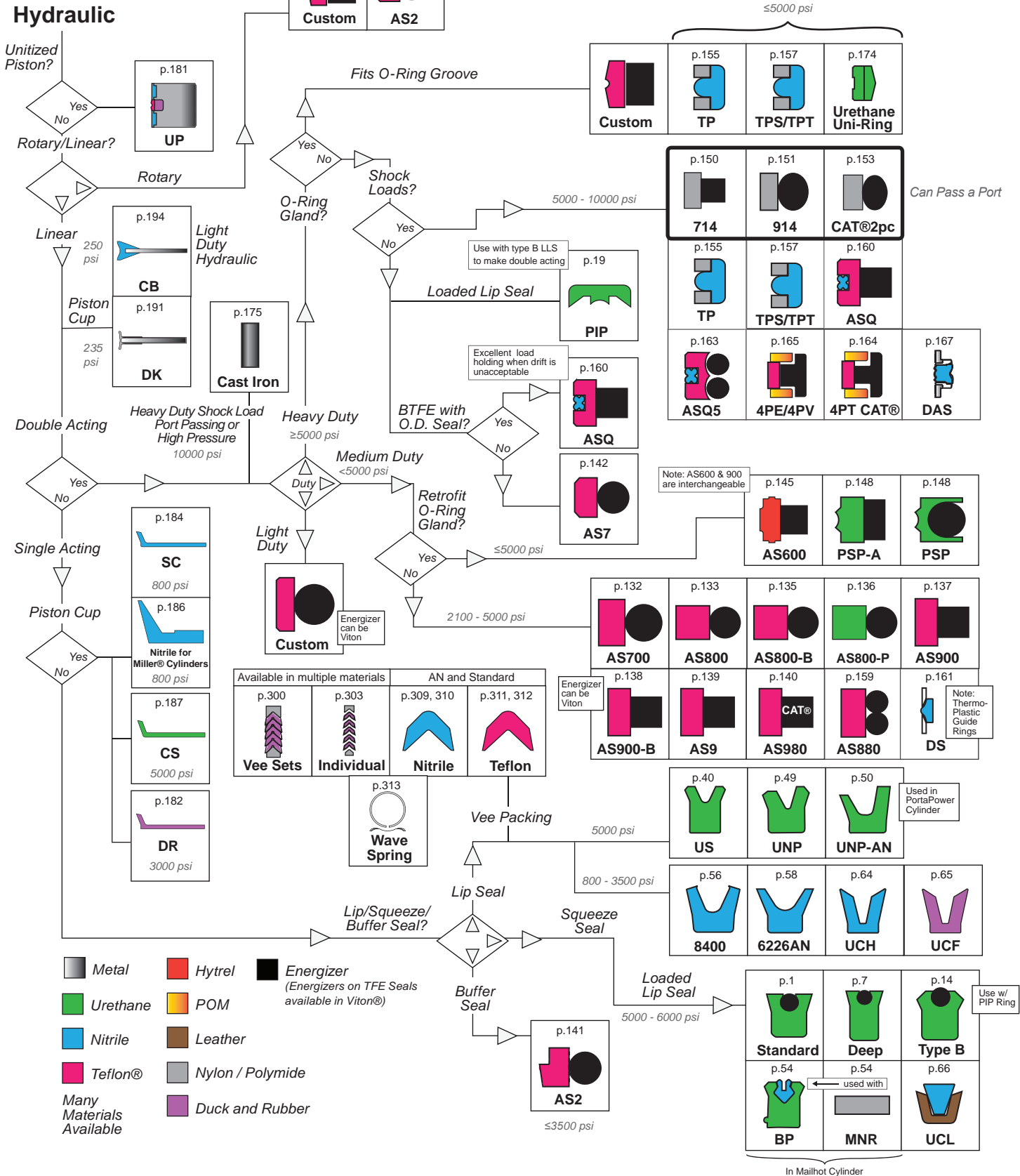

Piston Seal Applications

Hydraulic

Metric Sizes

Over 40 Styles in Stock
 Custom Machined Piston Profiles pg. IX

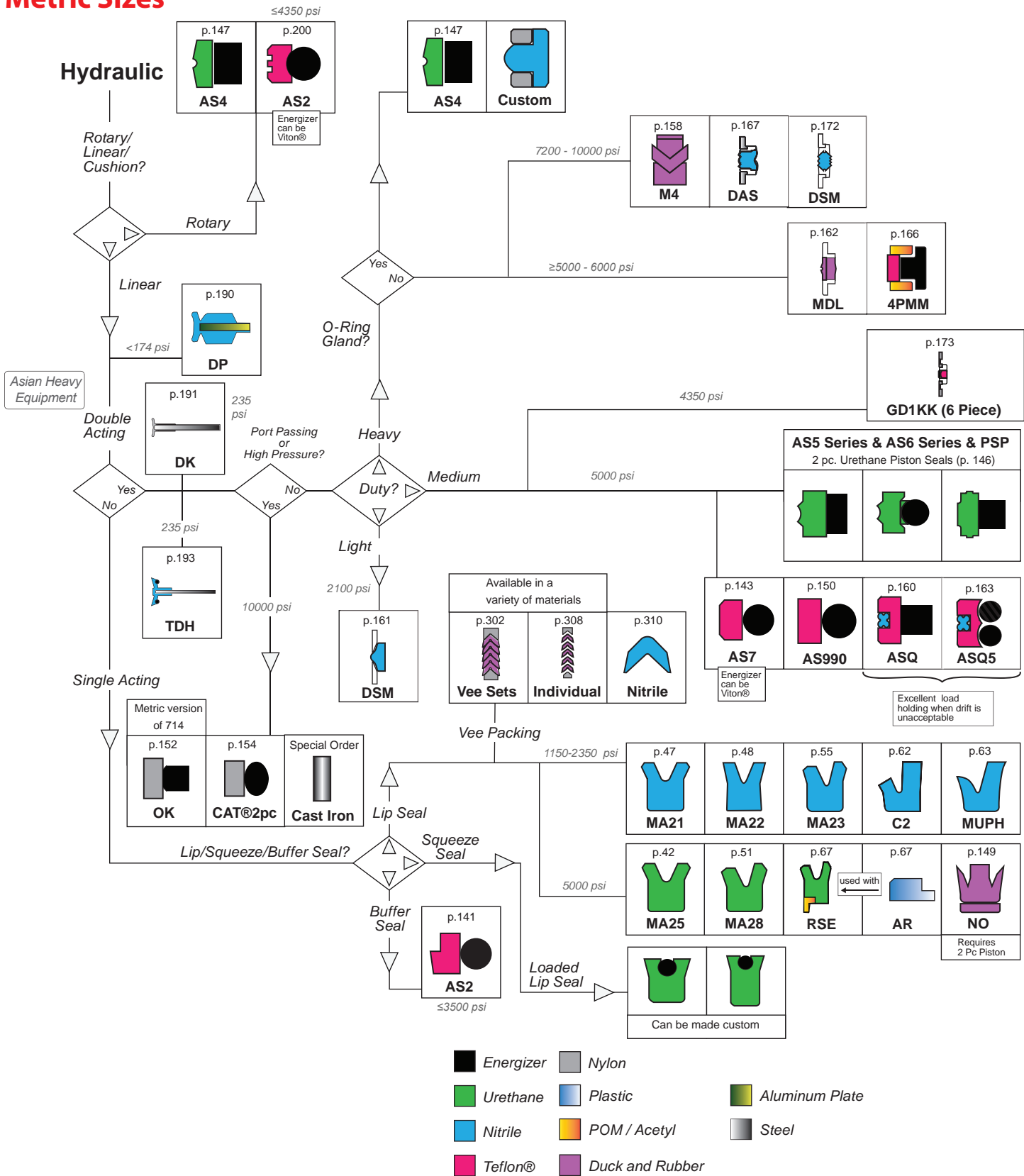

O-Rings

Inch and Metric Sizes

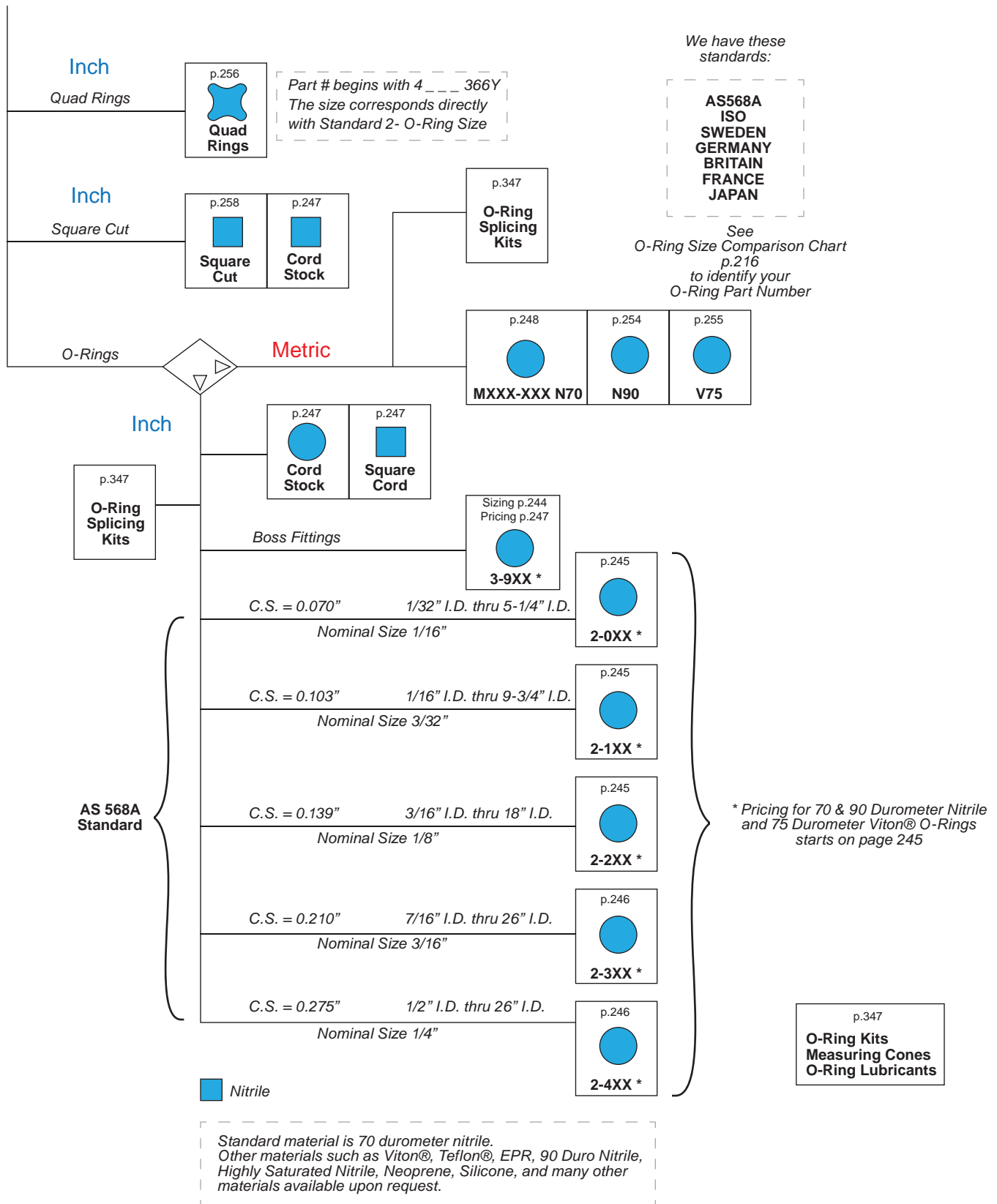

Backup Rings

Inch and Metric Sizes

See Backup Ring Interchange Guide (p. 261) for contoured nitrile, leather, TFE Solid/Split/ Spiral backups that correspond to standard O-Rings

Custom Machined Profiles pg. IX

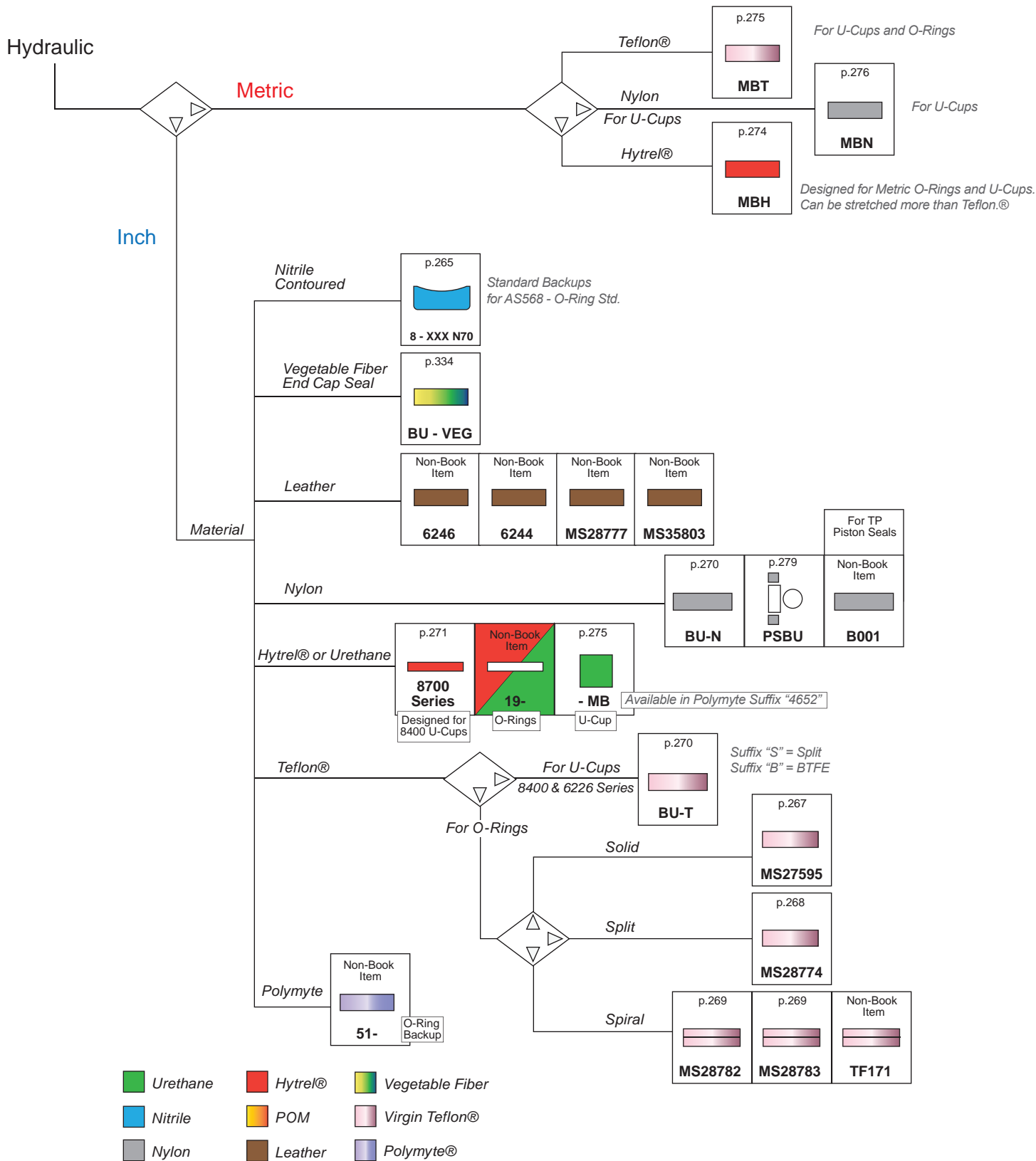

Wearband / Guide Bearings

Inch and Metric Sizes

Telescopic Wearband / Guide Bearings available p.349 - p.362

Replacement parts for:
 Parker®, Custom Hoist®, Hyco®, Hyva®, Ward®, Galion®, and Perfection®

Custom Machined Profiles pg. IX

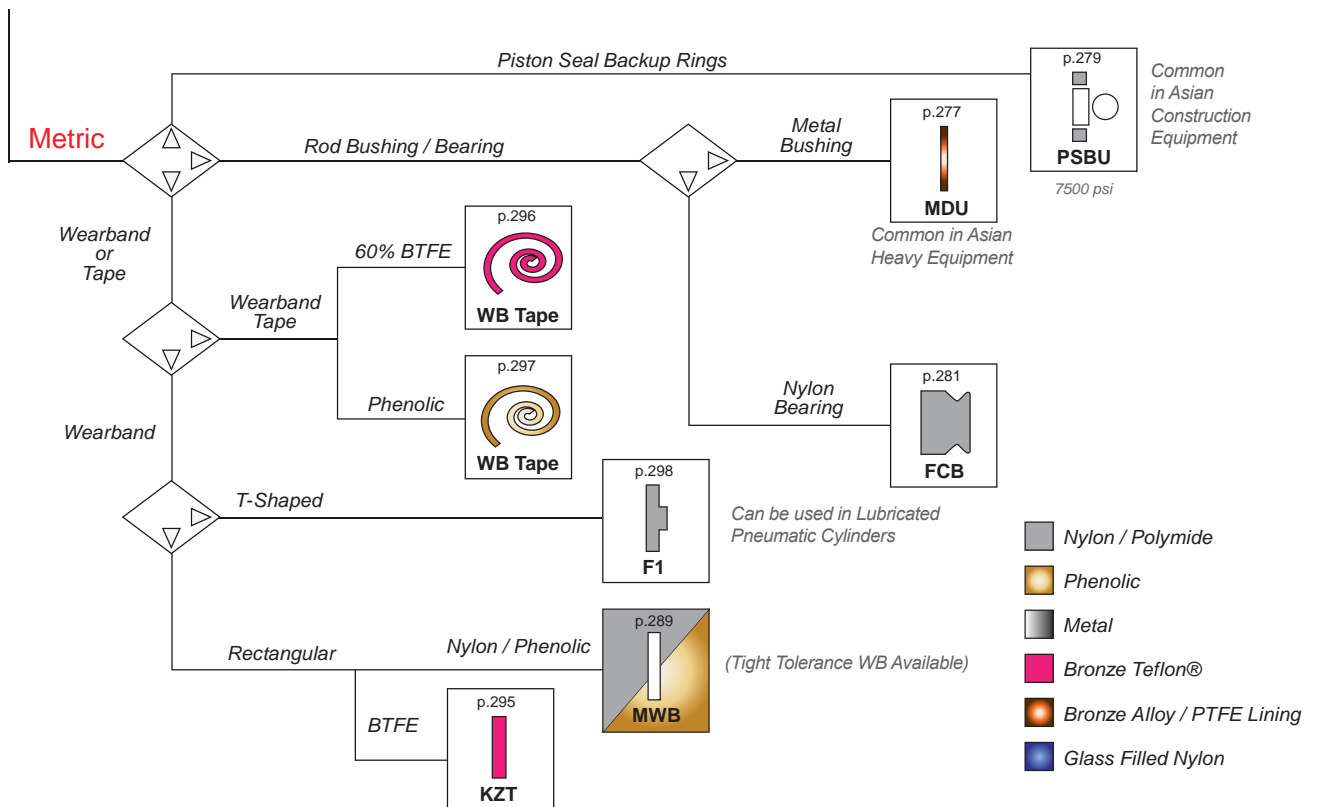
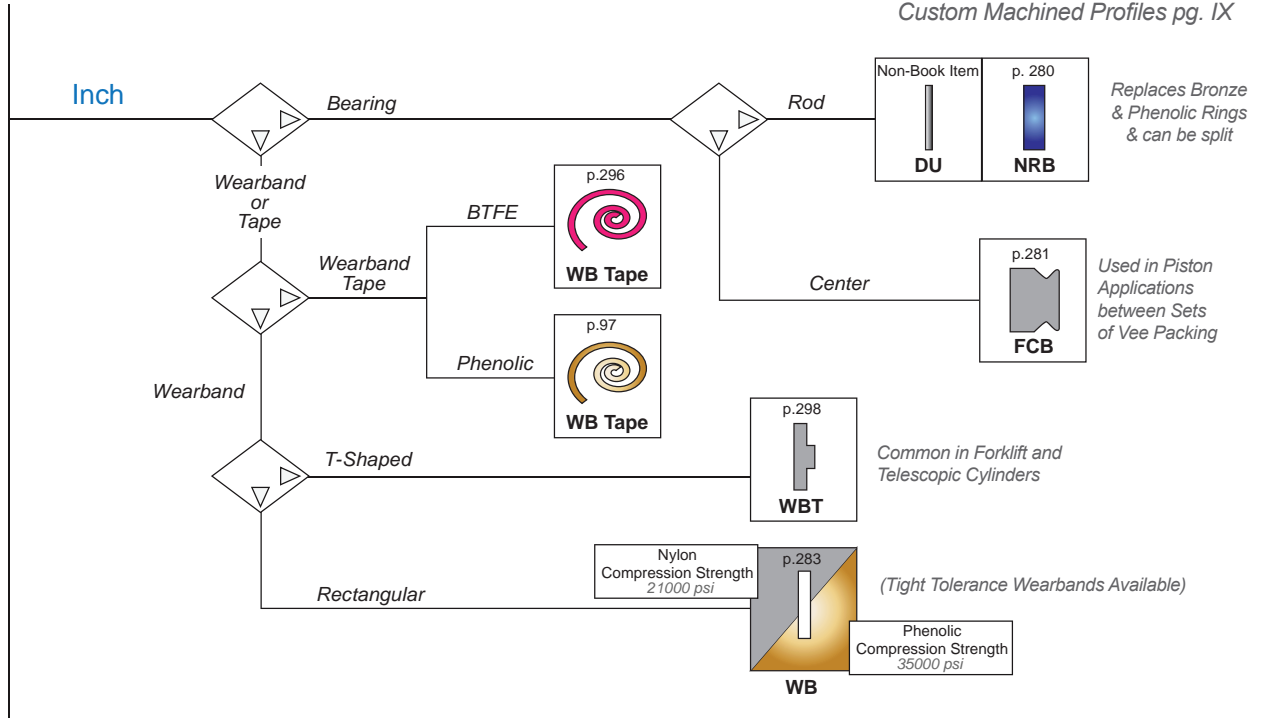

- Nylon / Polyimide
- Phenolic
- Metal
- Bronze Teflon®
- Bronze Alloy / PTFE Lining
- Glass Filled Nylon

Rotary Swivel and Shaft Seal Applications





Hydraulic

Inch and Metric Sizes

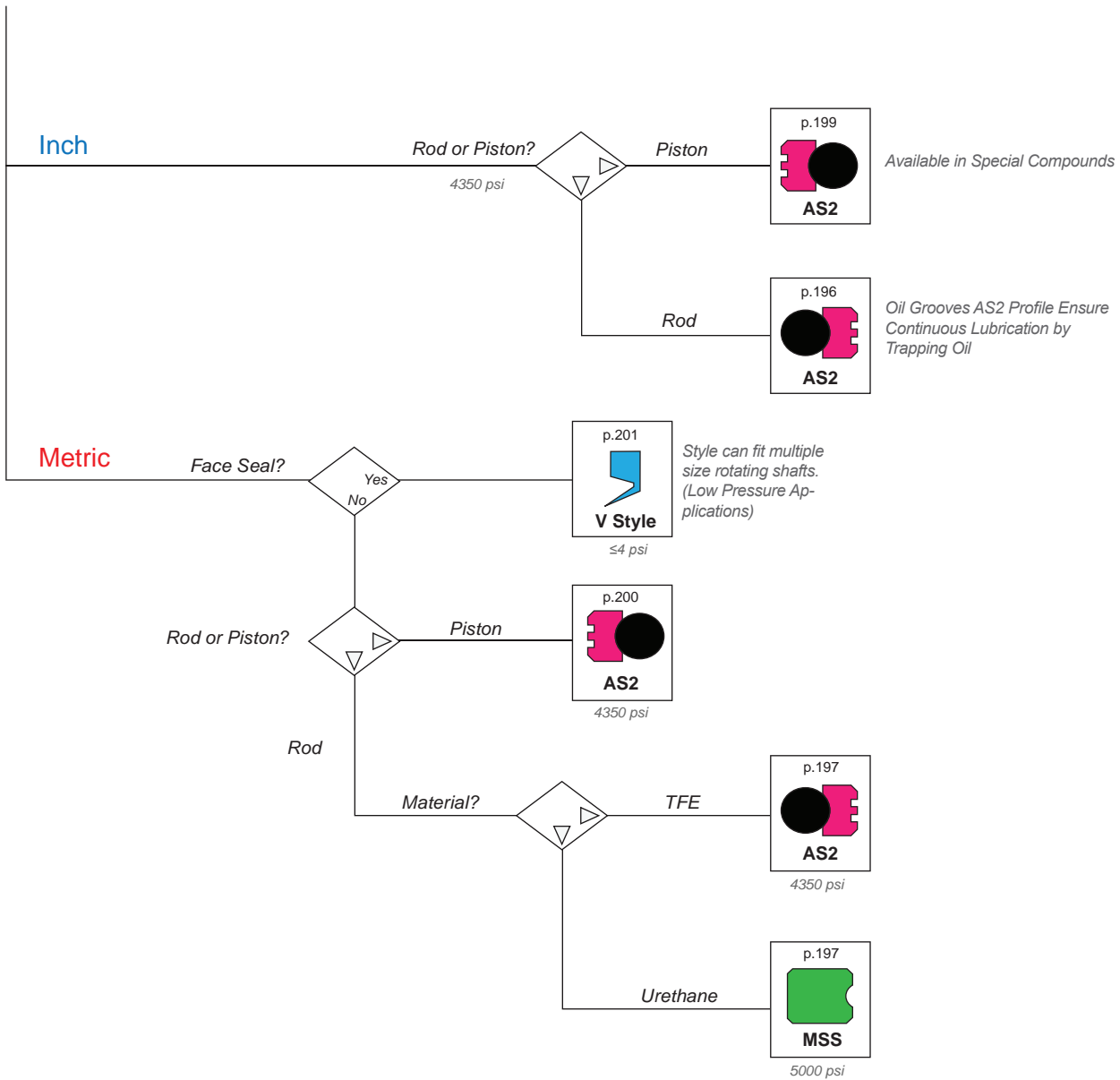
Custom Machined Profiles pg. VIII

Hydraulic



-  Energizer (Available in Special Compounds)
-  Urethane
-  Nitrile
-  Teflon® (Carbon Graphite Filled)

Wiper Applications

Pneumatic

Inch Sizes

6 Styles in Stock

Custom Machined Wiper Profiles pg. IX

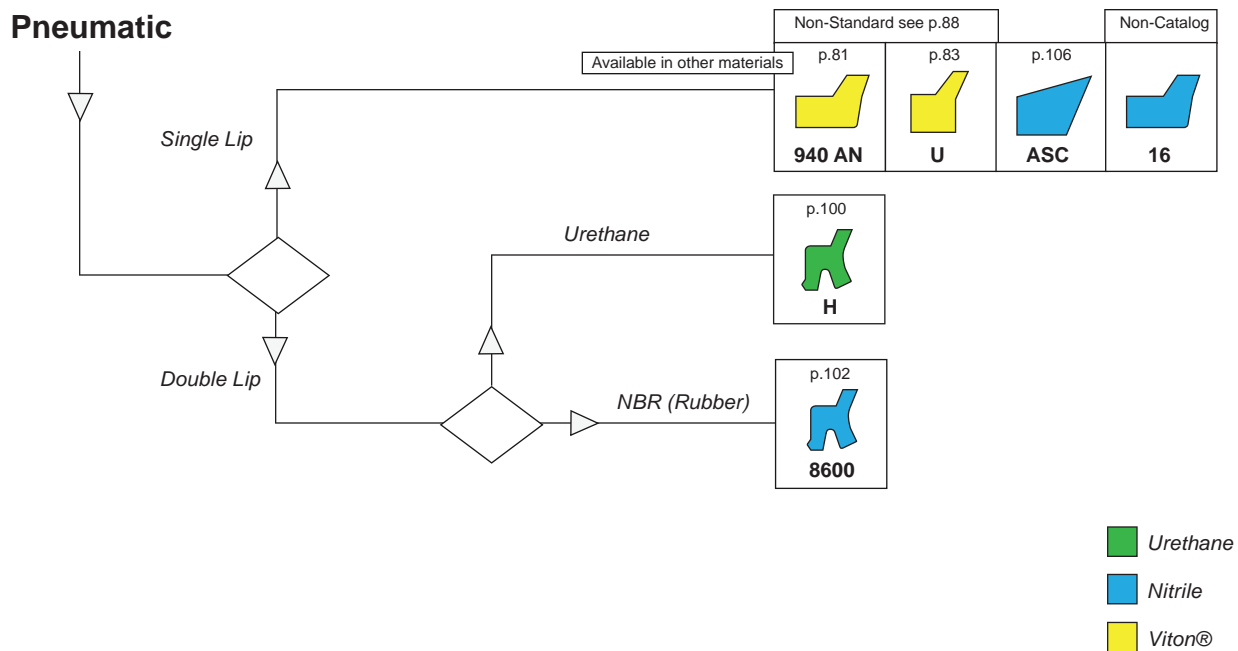

Wiper Applications

Pneumatic

Metric Sizes

15 Styles in Stock

Custom Machined Wiper Profiles pg. VIII

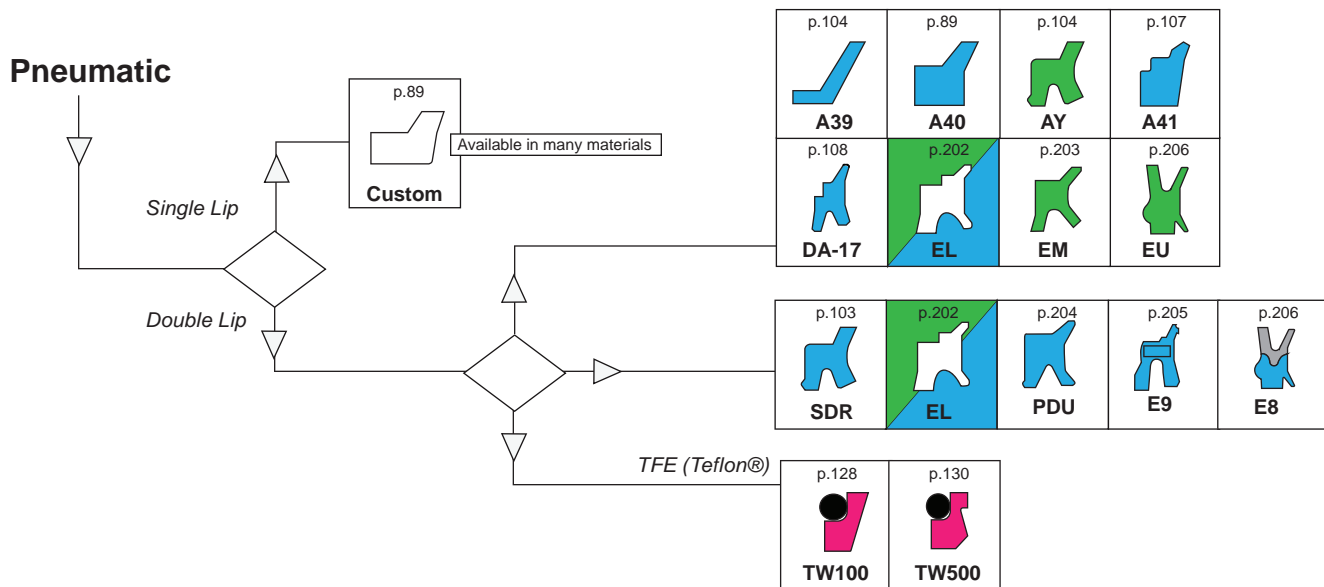

Material Availability

- Urethane
- Nitrile
- Teflon®
- Nylon
- Energizers can be Nitrile or Viton

Rod Gland Seal Applications

Pneumatic

Inch Sizes

6 Styles in Stock

Custom Machined Rod Profiles pg. IX

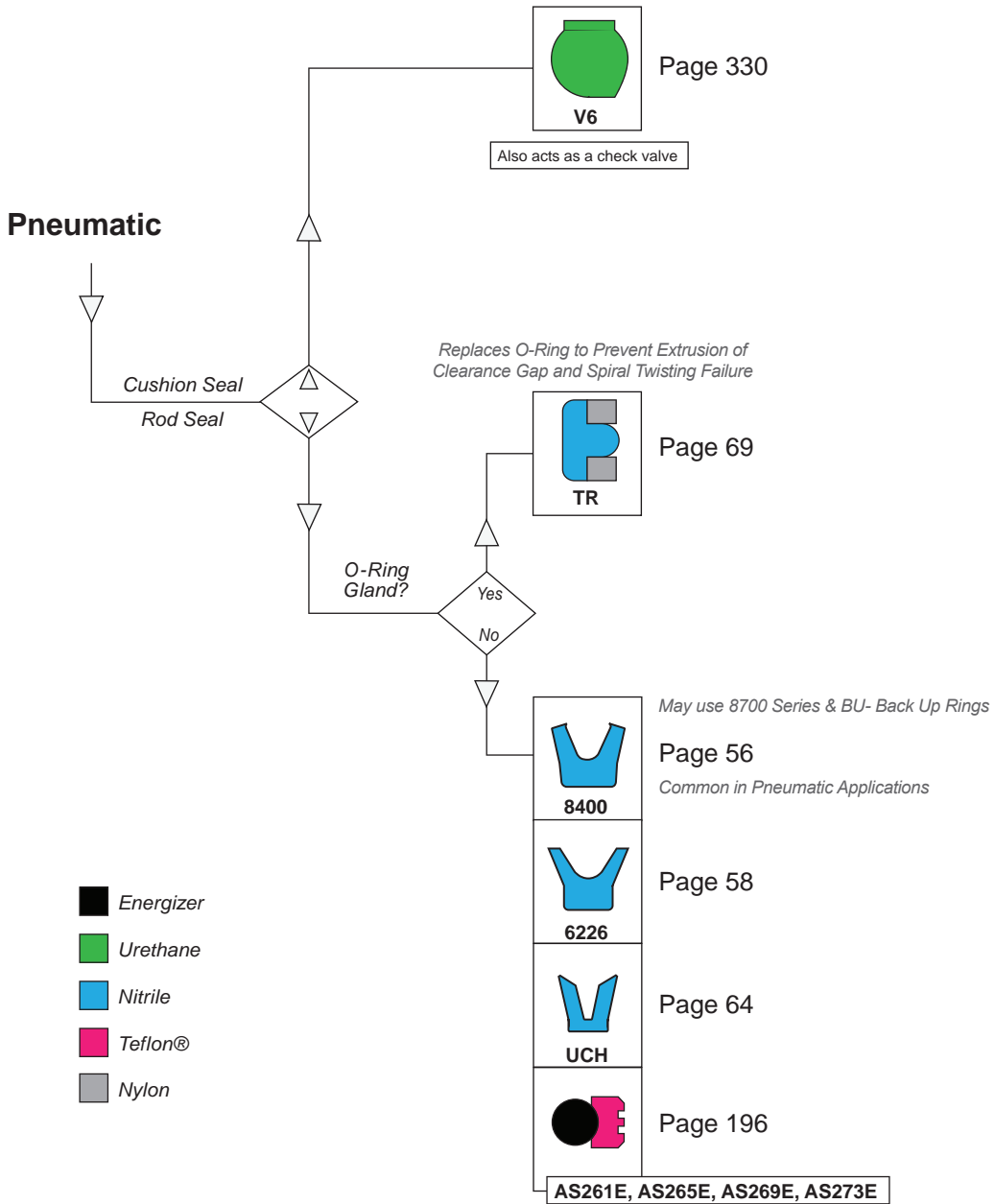

Rod Gland Seal Applications

Pneumatic

Metric Sizes

10 Styles in Stock

Custom Machined Rod Profiles pg. IX

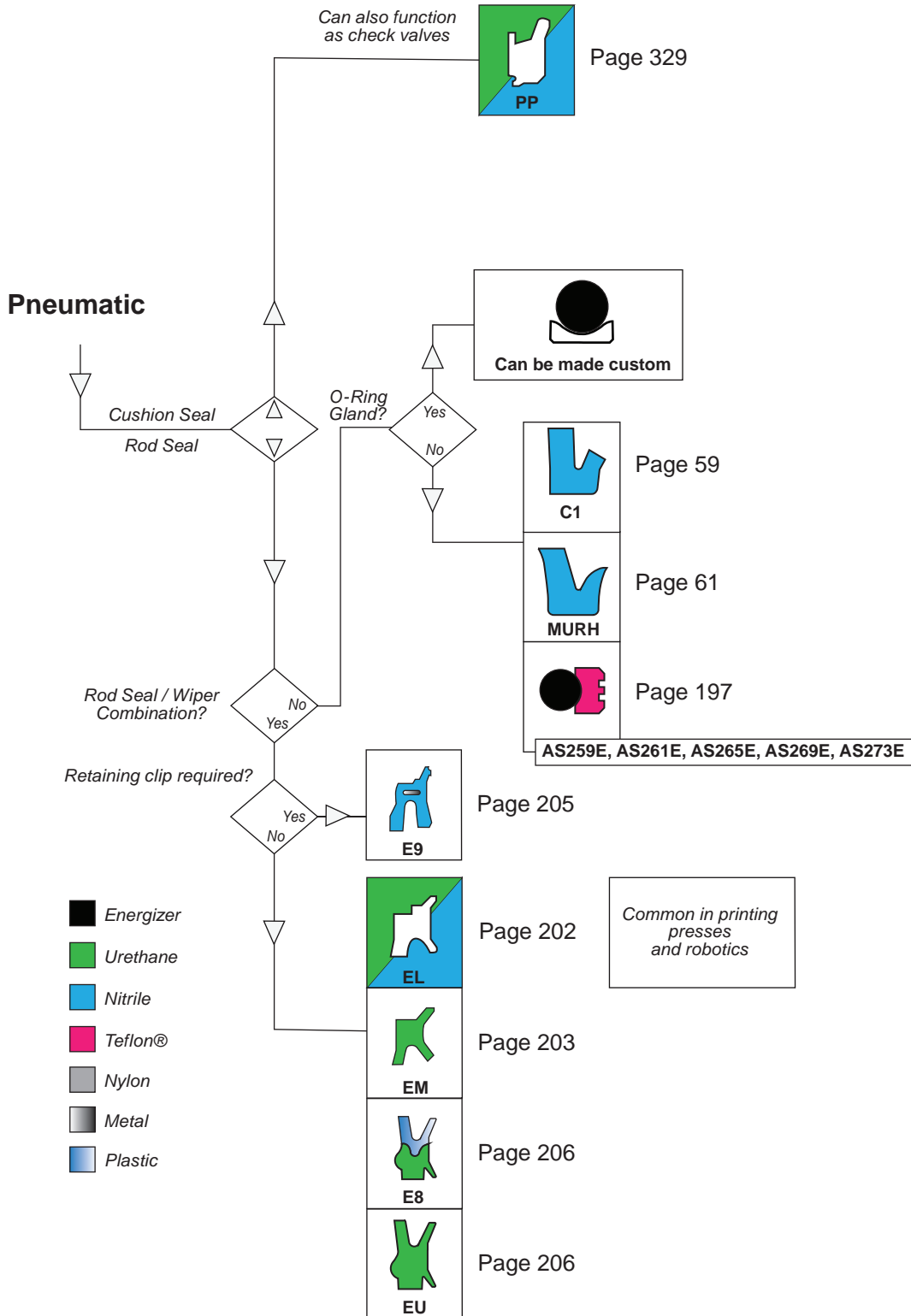

Piston Seal Applications

Pneumatic

Inch Sizes

Over 15 Styles in Stock

Custom Machined Piston Profiles pg. IX

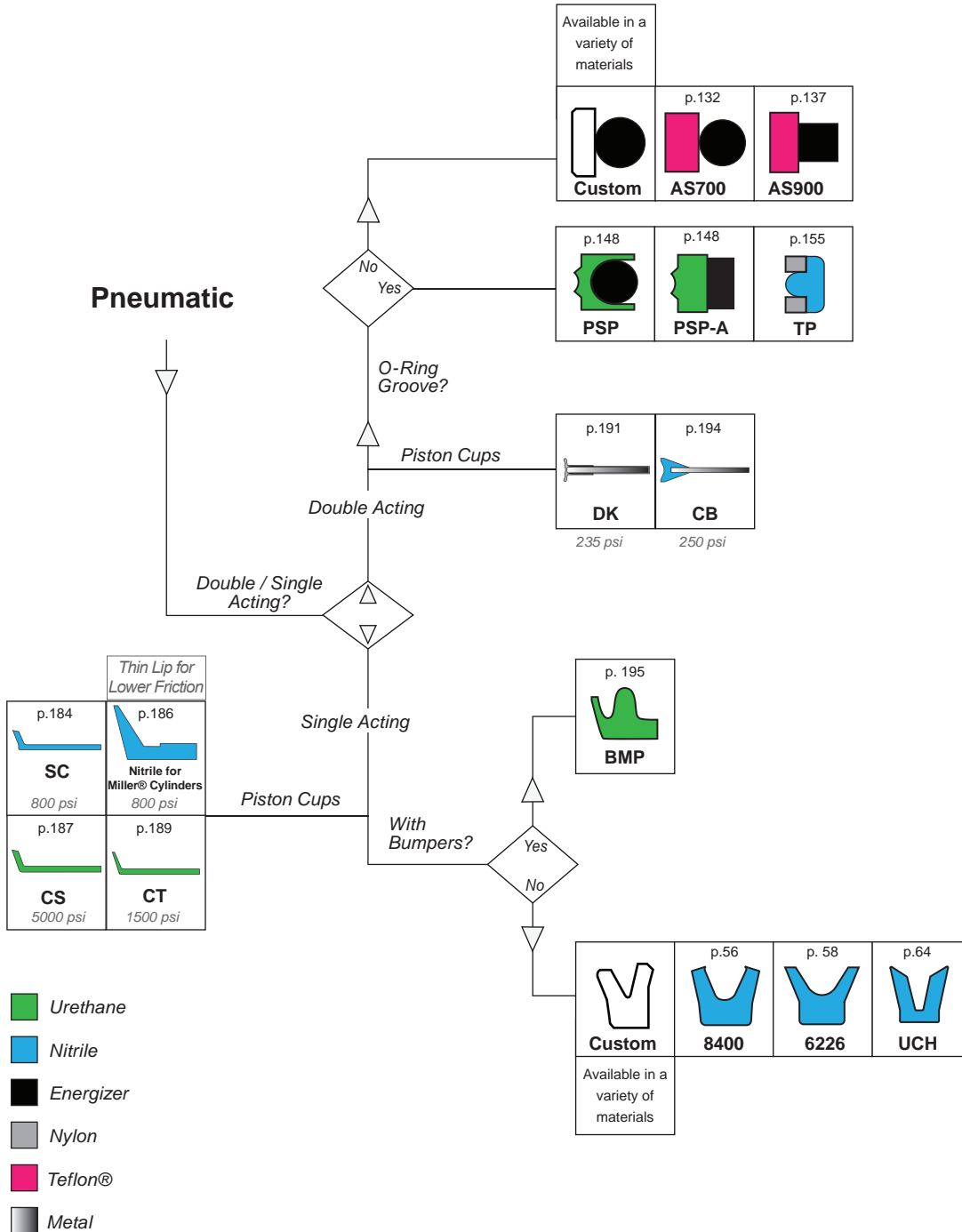

Piston Seal Applications

Pneumatic

Metric Sizes

13 Styles in Stock
Custom Machined Piston Profiles pg. IX

